

EDGE P

Podiatry Examination/
Surgery Chair



 EDGE SURGICAL SOLUTIONS

WHO WE ARE | QUI NOUS SOMMES | CHI SIAMO

THE COMPANY

EDGE SURGICAL SOLUTIONS is specialized in developing and manufacturing Multispecialty Examination and Surgery Chairs, Surgeon's Stools and Furniture.

EDGE SURGICAL SOLUTIONS is committed to the continuous research of innovative technical solutions for the Professionals; the range of equipment offered is based on and follows rigid guidelines: latest technology, perfect work-flow ergonomics, reliability, design and highly intuitive and easy to operate by the Professional.

The Company is directly involved through all development, manufacturing, assembly and quality control, shipment, installation and after-sale service phases thanks to its vast network of Distributors and Agents.

In the Company premises there is a permanent Show-Room and a Training Area for theory-practice sessions.

A well structured company organization that has enabled EDGE SURGICAL SOLUTIONS to grow at national and international level keeping the highest quality standards and constant innovation of its range of products.

ENTREPRISE

EDGE SURGICAL SOLUTIONS est spécialisée dans la conception et la fabrication de Fauteuils Polivalents et pour la Chirurgie Ambulatoire, Siège Praticien et Meubles.

EDGE SURGICAL SOLUTIONS est engagée dans la recherche constante de solutions innovantes pour les opérateurs professionnels; la gamme qu'elle propose suit des directives très précises: ergonomie, fiabilité, design et une simple utilisation pour les opérateurs.

La Société est directement impliquée dans chaque phases de conception et de développement de ses produits, à partir de la production et l'assemblage, au contrôle, jusqu'à l'expédition et la distribution, offrant un support technique et commercial complet et compétent. Tout cela grâce à un réseau coordonné et capillaire reliant ses agents et ses partenaires-distributeurs et grâce à son service après-vente interne.

A l'intérieur de son établissement, EDGE SURGICAL SOLUTIONS propose une salle d'exposition permanente et une salle de formation pour l'entraînement théorique et pratique.

Une organisation qui nous a permis de nous développer au bout des années sur le marché Nationale et Internationale, toujours en gardant les plus hauts standards de qualité et un renouvellement constant de notre gamme de produits.



“All EDGE SURGICAL SOLUTIONS Medical Equipment is designed, developed and manufactured in Italy”

L'AZIENDA

EDGE SURGICAL SOLUTIONS è specializzata nella progettazione e nella fabbricazione di Poltrone Chirurgiche Multispecialistiche, Seggiolini Chirurgici e Arredi.

EDGE SURGICAL SOLUTIONS è impegnata nella continua ricerca di soluzioni innovative per gli Operatori professionali; la gamma che propone si basa su linee guida molto rigide: ergonomia, affidabilità, design e massima semplicità di utilizzo per gli Operatori.

L'Azienda è direttamente coinvolta in tutte le fasi di progettazione e sviluppo, produzione e assemblaggio, controllo, spedizione e commercializzazione, offrendo un supporto tecnico e commerciale completo e competente grazie ad una rete capillare di Agenti e Distributori ed un Servizio Assistenza Interno.

Nella sua sede EDGE SURGICAL SOLUTIONS offre uno Show-room permanente ed una Sala Corsi per la Formazione.

Una organizzazione aziendale che ci ha permesso in pochi anni di crescere a livello nazionale ed internazionale mantenendo i più alti standard qualitativi e il rinnovamento costante della gamma prodotti.



HOW WE WORK | COMMENT NOUS TRAVAILLONS | COME LAVORIAMO

R&D

EDGE SURGICAL SOLUTIONS R&D Team develops internally all the equipment and devices for the Professionals and Clinics, always combining modern and essential design to the latest and most innovative technical solutions.

L'équipe EDGE SURGICAL SOLUTIONS Design développe en interne tout équipements dédiés au Professionnel et à la Cabinet, toujours en alliant un design moderne avec les solutions techniques les plus fonctionnelles et innovantes.

Il Team di Progettisti EDGE SURGICAL SOLUTIONS sviluppa internamente tutte le attrezzature dedicate al Professionista e alla Clinica, coniugando sempre con attenzione un design moderno alle soluzioni tecniche e funzionali più innovative.



R&D
R&D
R&D



EDGE SURGICAL SOLUTIONS manufactures a wide and complete range of Surgical Chairs, Doctor Stools and Furniture. Every single production phase is planned and performed according to the most rigid quality control criteria.

EDGE SURGICAL SOLUTIONS réalise sa gamme complète de Fauteuils de Chirurgie, Sièges Praticien et Meubles. Chaque phase de la production est organisée suivant des critères très stricts de qualité et de contrôle.

EDGE SURGICAL SOLUTIONS produce una gamma completa di Poltrone Chirurgiche, Sgabelli e Arredi. Ogni fase produttiva è organizzata secondo rigidi criteri di qualità e controllo.



PRODUCTION
PRODUCTION
REALIZZAZIONE

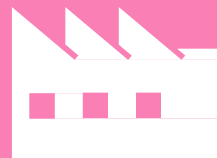

EDGE SURGICAL SOLUTIONS will design your Ambulatory Surgery Center in order to allow for the best work-flow and ergonomics while guaranteeing maximum comfort to the Patient, according to the space availability and your different set up needs as a Professional.

Nous étudions les meilleures solutions de projet pour votre Salle de Chirurgie Ambulatoire, afin de vous garantir une parfaite ergonomie et un maximum de confort, tout en gardant toujours les solutions les plus adaptées à votre espace.

Progettiamo il tuo Ambulatorio Chirurgico per garantirti la migliore ergonomia di lavoro e il massimo comfort proponendo sempre le soluzioni più adeguate al tuo spazio.



PROJECT
PROJET
PROGETTO



INSTALL
INSTALL
INSTALL



All EDGE SURGICAL SOLUTIONS equipment is "Plug-in & Work" easy to set up and ready to use with very few and easy installation steps. EDGE SURGICAL SOLUTIONS guarantees a highly professional installation service thanks to its vast network of Distributors and Agents, and a product specialist will train the Ambulatory staff on the correct use of the installed equipment.

Tous les équipements EDGE SURGICAL SOLUTIONS sont fabriqués suivant le principe du "Plug-in & Work", facile à installer et avec un service d'expédition et de livraison consolidés. EDGE SURGICAL SOLUTIONS garantit un service professionnel d'installation de votre Cabinet grâce à un réseau de distributeurs impliqués dans chaque phase. Un de nos technico-commerciaux vous garantira une formation complète pour l'utilisation de tout équipements à l'intérieur de votre Cabinet.

Tutte le Attrezzature EDGE SURGICAL SOLUTIONS sono realizzate con il principio del "Plug-in & Work", facili da installare e con un servizio di spedizione e consegna dedicato. EDGE SURGICAL SOLUTIONS garantisce un servizio professionale di allestimento del tuo Ambulatorio grazie ad una vasta rete di Distributori che ne seguono ogni fase. Un nostro product specialist garantirà la formazione in loco sull'utilizzo delle attrezzature installate nel tuo Ambulatorio.



EDGE SURGICAL SOLUTIONS is committed to continuous training and information of all its Customers; the Company can rely on the cooperation with prominent experts in each medical discipline and often involved in training sessions on the specific equipment and different operating methods.

EDGE SURGICAL SOLUTIONS connaît l'importance de promouvoir de l'information et de la formation de tous ses clients, en collaboration avec des experts du secteur et en organisant des sessions de formations dédiées aux équipements et à techniques très spécifiques.

EDGE SURGICAL SOLUTIONS promuove da sempre l'informazione e la formazione dei suoi clienti collaborando con prominenti esperti di settore e organizzando sessioni e corsi di formazione dedicati alle varie e specifiche attrezzature e metodiche operative.



EDGE SURGICAL SOLUTIONS considers Warranty a professional duty and mandatory towards all its Customers, reason being the Company extends guarantee of the equipment up to 2 Years on Electronic Parts and up to 5 Years on Mechanic Parts.

EDGE SURGICAL SOLUTIONS considère la garantie des produits comme un engagement ferme envers tous ses clients. Pour cette raison, la garantie de nos équipements couvre jusqu'à 2 ans pour les composants électroniques et jusqu'à 5 ans tout composants mécaniques.

EDGE SURGICAL SOLUTIONS considera la Garanzia dei prodotti un dovere verso tutti i suoi clienti e per questo garantiamo le nostre attrezzature fino a 2 anni per le componenti elettroniche e fino a 5 anni per tutte le componenti meccaniche.

All Customers can rely on a punctual and qualified after-sale assistance thanks to the in-house Service Department. You will be able to request a Preventive Maintenance and Courtesy Service to our Distributors and avoid any unexpected interruption of your professional activity.

Nos clients peuvent compter sur un SAV rapide et qualifié, grâce à son Département interne. Vous aurez également la possibilité de profiter d'un service de maintenance programmé, ainsi que d'un "Service de Courtoisie" assuré par nos Distributeurs afin d'éviter toute interruption de votre activité professionnelle.

I nostri clienti possono contare su un Servizio di Assistenza puntuale e qualificato grazie al dipartimento Service interno. Avrai la possibilità di richiedere un Servizio di Assistenza Programmata e il Servizio "Cortesia" al Distributore incaricato per non avere mai interruzioni della tua attività professionale.



INSTALLATION
INSTALLAZIONE



TRAINING
FORMATION
FORMAZIONE



WARRANTY
GARANTIE
GARANZIA



SERVICE
SERVICE APRES-VENTE
ASSISTENZA





 EDGE SURGICAL SOLUTIONS

Registered Community Design

EDGE P

Podiatry Examination/ Surgery Chair

It is the ultimate concept developed by SURGICAL SOLUTIONS specifically *par* designed for Podiatry and Pedicure.

It is an innovative Examination/Procedure Chair with a modern design whose key words are: Solidity and Technical Innovation.

is able to push forward all quality standards thanks to

- Innovative technology and modern design
- Perfect patient medical positioning
- Doctor's ergonomics and ready access for the patient
- Extremely efficient work-flow
- Precise and comfortable positioning of the patient's foot
- Complete operational view of the treatment area.

Est le concept incontournable développé EDGE SURGICAL SOLUTIONS exprèsment conçu pour la Pedicure et la Podologie.

Est un Fauteuil innovant au design très original tout en respectant un cahier de fonctions et de charges rigoureux dont les maîtres mots sont: Solidité et Innovation technique.

va pousser plus loin tous les standards de

- *Qualité*
- *Une technologie innovante et un design moderne*
- *Possibilité de positionner toujours correctement le patient*
- *Hauteur maximale capable de garantir une ergonomie idéale de l'Opérateur*
- *Un flux de travail très efficace*
- *Positionnement précis et confortable du pied du patient*
- *Visuel parfaitement complet de la zone du traitement.*

E' il nuovo concetto sviluppato da EDGE EDGE SURGICAL SOLUTIONS specificamente ideato per la Podologia.

E' una poltrona innovativa dal design originale, che rispetta rigorosi criteri di funzionalità e le cui parole chiave sono: Solidità e Innovazione tecnica.

è in grado di spingere più lontano tutti gli standard di qualità attraverso:

- una tecnologia innovativa e un design moderno
- la possibilità di posizionare sempre correttamente il Paziente
- l'altezza massima in grado di garantire un'ergonomia ideale dell'Operatore
- un flusso di lavoro molto efficiente
- Il posizionamento preciso e confortevole del piede del Paziente



 EDGE SURGICAL SOLUTIONS

Registered Community Design

EDGE P

It is equipped with a solid metal structure, painted with epoxy powder and powered by 2 linear actuators and a telescopic column controlled by a wireless multifunctional pedal. Ready access thanks to the 90° lateral opening leg-rests and perfect patient

medical positioning thanks to the EDGE SURGICAL SOLUTIONS foot control, equipped with a memory system up to 3 memorizable working positions and automatic return to the entry/exit position. Ideal ergonomics and efficient workflow.

Main features:

- Lifting movement by telescopic column
- Trendelenburg movement and backrest inclination by linear actuator
- 3 memorizable working positions with automatic return at the end of the treatment
- Padded arm-rests movement always parallel to the seat
- Mechanical leg-rests with extending heel support and 90° lateral opening
- Rotation of the chair 360°
- Modern and elegant upholstery, technical and durable with a choice of more than 50 different colors and textures
- Lifting capacity 325 Kg
- Front access of the patient thanks to the 90° opening of the leg-rests
- Anti-pinch safety system with automatic stop
- Head-rest included in the standard version
- Possibility to provide accessories to fix on the side steel rail, such as a 6000Lux LED lamp or a stainless steel instruments tray

Il est équipé d'une structure métallique solide, peinte avec poudre époxydique et actionnée par 2 moteurs et une colonne télescopique commandée par une pédale

multifonctions sans fil. La pédale EDGE SURGICAL SOLUTIONS est équipée avec un système de programmation jusqu'à 3 positions et retour automatique à la position d'accès. La sellerie comprend 3 sections rembourrées détachables pour faciliter le nettoyage et la désinfection. Le skai de revêtement est disponible en plus de 50 couleurs et textures différentes.

Principales caractéristiques :

- Montée / Descente par colonne télescopique
- Mouvement de Trendelenburg et inclinaison du dossier par actuateur linéaire
- 3 Positions mémorisables avec retour automatique en fin de soin
- Accoudoirs à fixation dorsale rembourrés et parallèles aux mouvements de l'assise
- Jambières mécaniques avec mouvements d'allongement et d'ouverture latérale à 90°
- Rotation du fauteuil avec amplitude de 90° gauche et droite
- Revêtement spécifique, très technique et durable, avec un choix plus de 50 couleurs et textures différentes
- Capacité de levage 325 Kg avec force constante
- Accessibilité frontale du patient grâce à l'ouverture 90° des jambières
- Sécurité anti-pincement avec arrêt automatique et immédiat
- Tête incluse de série
- Possibilité de prévoir des accessoires à fixer sur le support métallique lateral, comme une lampe LED 6000Lux ou le plateau instruments pivotant

E' costruita su una solida struttura metallica, verniciata con polvere epossidica e dotata di 2 attuatori lineari ed una colonna telescopica. Tutti i movimenti sono gestiti da un pedale

multifunzionale wireless. La pedaliera EDGE SURGICAL SOLUTIONS è dotata di un sistema di programmazione che consente la selezione di 3 posizioni memorizzabili, oltre al ritorno automatico della poltrona alla posizione di accesso (zero)

La struttura della poltrona include 3 sezioni amovibili imbottite, che consentono una perfetta pulizia e disinfezione. Il rivestimento in skai è disponibile in oltre 50 diversi colori e trame.

Caratteristiche principali:

- Salita / discesa tramite colonna telescopica
- Movimento Trendelenburg e inclinazione dello schienale tramite attuatore lineare
- 3 posizioni memorizzabili con ritorno automatico della poltrona alla posizione di accesso (zero)
- Braccioli imbottiti a fissaggio dorsale e paralleli al movimento della seduta
- Gambali meccanici estensibili e divaricabili con apertura a 90°
- Rotazione di 90° a sinistra e a destra
- Rivestimento in materiale tecnico e molto resistente, con possibilità di scelta tra oltre 50 diversi colori e trame.
- Capacità di sollevamento 325 Kg con forza costante
- Accessibilità frontale del Paziente grazie all'apertura dei gambali a 90°
- Sistema automatico anti-shock con arresto immediato dei movimenti in presenza di ostacoli
- Poggiatesta incluso di serie
- Possibilità di applicazione di numerosi accessori da fissare sul supporto metallico laterale, come una lampada LED 6000Lux o un vassoio strumenti



plug & work



wireless



memory



zero position



disinfection



3motors



80 colours available

Registered Community Design

code	description
9110501-W	EDGE P (white structure)
9110501-S	EDGE P (silver structure)

EDGE P



The chair reaches a minimum height of 51 cm allowing patients with different medical conditions to easily access the chair from the front or the sides without any barrier.

Il atteint une hauteur minimum de 51 cm permettant aux patients souffrant de différentes conditions d'accéder facilement au fauteuil par l'avant ou des côtés, sans aucune barrière.

Raggiunge un'altezza minima di 51 cm consentendo ai Pazienti con condizioni di mobilità ridotta ad accedere facilmente alla poltrona sia frontalmente sia lateralmente.



The chair can horizontally rotate 360°. The lever allows the Operator to rotate and stop the rotation of the chair.

La rotation du fauteuil suit un mouvement mécanique horizontale de 360°. Le levier positionné en bas du fauteuil permet à l'Opérateur d'arrêter la rotation du fauteuil.

La rotazione della poltrona segue un movimento meccanico orizzontale di 360°. La leva posizionata nella parte inferiore della poltrona consente all'Operatore di bloccare la rotazione.

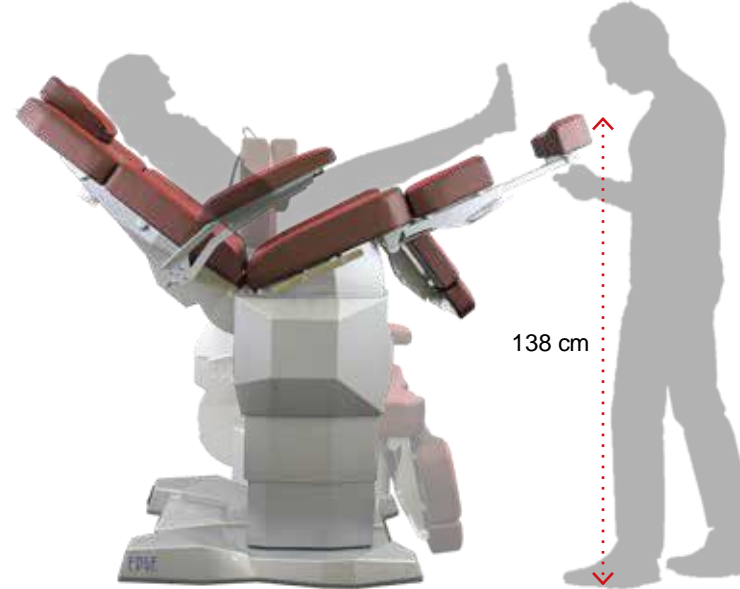

The chair reaches the height of 138 cm at maximum leg-rest extension.

Le fauteuil atteint une hauteur maximale de 138 cm avec l'axe des jambes allongés.

La poltrona raggiunge un'altezza massima di 138 cm con massima estensione del gambale.

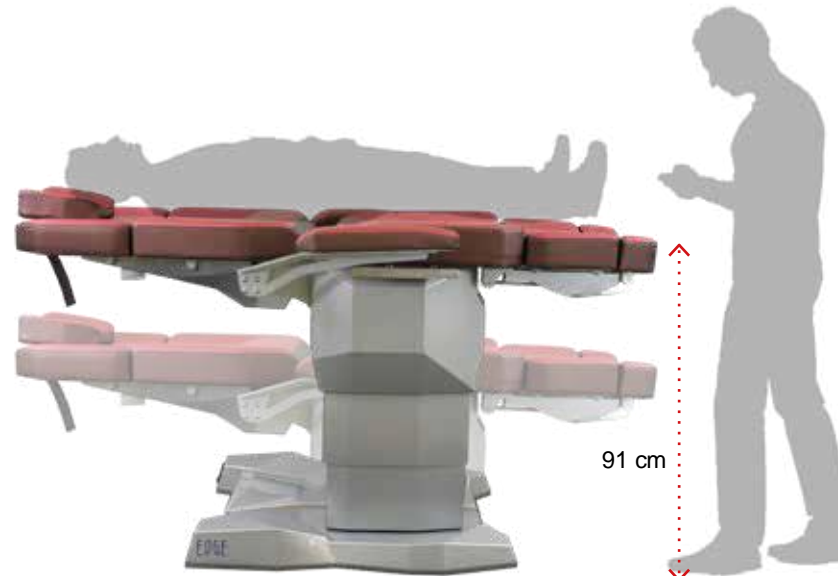

The chair can reach a perfect flat position at any height, for the maximum comfort of the Operator while performing a clinical examination or professional treatment. Maximum height 91 cm.

Le fauteuil peut atteindre une position parfaitement plate à n'importe quelle hauteur, pour le maximum de confort pour l'opérateur lors d'un examen ou un traitement professionnel. Hauteur maximum 91 cm.

Raggiunge la posizione di lettino perfetta ed a qualsiasi altezza, per garantire il massimo comfort per l'Operatore durante l'esame o il trattamento professionale. Altezza massima 91 cm.

EDGE P



Zero position of the chair.
The chair automatically reaches "0" position to facilitate the access and the exit of the Patient.

Remise à zéro du fauteuil. Le fauteuil atteint la position "0" automatiquement pour faciliter l'accès et la descente du Patient

Ritorno a zero. La poltrona raggiunge automaticamente la posizione "0" per facilitare l'accesso e la discesa del Paziente.



It reaches Trendelenburg position with 20° inclination.

Il atteint la position Trendelenburg avec une inclinaison de 20°.

Raggiunge la posizione Trendelenburg con un'inclinazione di 20°.



Lifting capacity of 325KG , one of the highest in its category.

Capacité de levage de 325KG, l'une des plus élevée de sa catégorie.

Capacità di sollevamento di 325 kg, uno dei più alti della sua categoria.



It is operated by a wireless control with modern design and extremely intuitive. Easy to operate and to clean, the foot control provides the Professional with an ergonomic and efficient working tool, useful to position the Patient comfortably and memorize different working or safety positions.

E' dotata di un comando foot a pedale wireless con un design moderno, funzioni semplici e intuitivo. Facile da usare e da disinfettare, il pedale garantisce all'Operatore uno strumento di lavoro ergonomico ed efficace, ideale per posizionare comodamente il Paziente grazie anche alla possibilità di memorizzare diverse posizioni di lavoro o di sicurezza.

PROVIDED IN THE STANDARD VERSION

FORNITO NELLA VERSIONE STANDARD

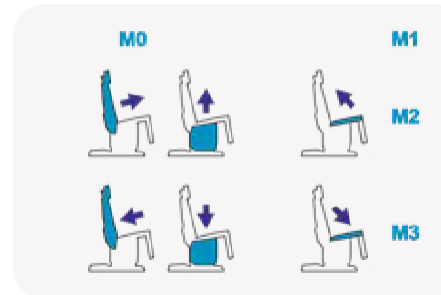

Il est équipé d'une commande au pied sans fil avec un design moderne, aux fonctions simples et intuitives. Facile à utiliser et à désinfecter, la pédale garantit au Professionnel un outil de travail ergonomique et efficace, idéal pour positionner confortablement le patient et mémoriser différentes positions de travail ou de sécurité

FOURNI DANS LA VERSION STANDARD

EDGE^P



It is provided in the standard version with the structure in White color or Silver at choice.

PROVIDED IN THE STANDARD VERSION

Il est fourni dans la version standard avec la structure en couleur Blanc ou Argent à choix.

FOURNI DANS LA VERSION STANDARD

E' fornita nella versione standard con la struttura di colore Bianco o Silver a scelta.

FORNITO NELLA VERSIONE STANDARD

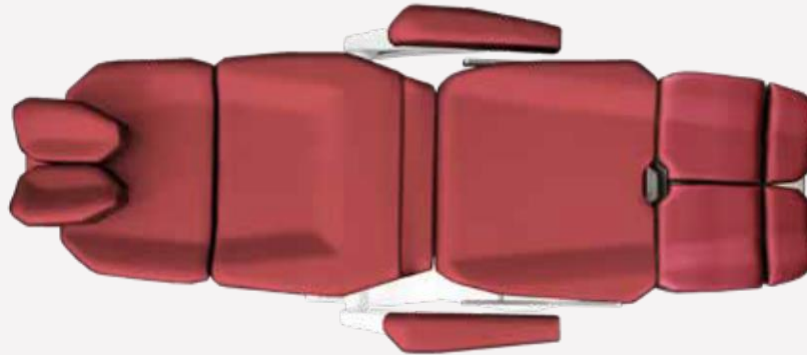

The upholstery comprises 4 separate padded sections fully detachable for easy cleaning and disinfection, made of high density undeformable foam and the cover is a bi-elastic, abrasion-resistant, flame retardant and antimicrobial medical grade Skai available in over 50 different colours and textures.

PROVIDED IN THE STANDARD VERSION

La tapisserie comprend 4 sections rembourrées entièrement détachables pour faciliter le nettoyage et la désinfection. Réalisée en mousse indéformable de haute densité et une couverture en Skai de catégorie médicale, bi-élastique, résistant à l'abrasion, ignifuge et antimicrobienne.

Disponibile dans plus de 50 couleurs et textures différentes.

FOURNI DANS LA VERSION STANDARD



La tappezzeria comprende 4 sezioni imbottite completamente rimovibili per una facile pulizia e disinfezione, realizzate in schiuma indeformabile ad alta densità e con un rivestimento in Skai bi-elastico, resistente all'abrasione, ignifugo e antimicrobico, disponibile in oltre 50 diversi colori.

FORNITO NELLA VERSIONE STANDARD



EDGE P



Anatomical adjustable head-rest for Patient's maximum comfort.
PROVIDED IN THE STANDARD VERSION

Anatomical adjustable head-rest for Patient's maximum comfort.
FOURNI DANS LA VERSION STANDARD

Poggiatesta anatomico regolabile per il massimo comfort del Paziente.
FORNITO NELLA VERSIONE STANDARD

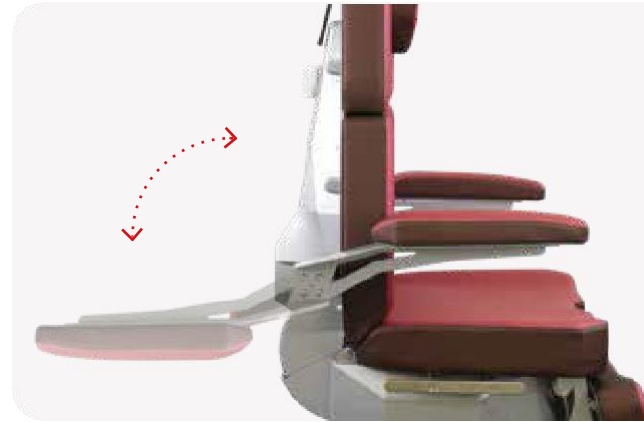

Arm-rest is shaped and padded and can all be completely removed when necessary. Both padded arm-rest are independently collapsible, removable and mechanically combined with the seat/back-rest movements ensuring comfort for the patient in any position.

PROVIDED IN THE STANDARD VERSION

Les accoudoirs sont rembourrés et peuvent être complètement enlevés si nécessaire.

Les deux accoudoirs rembourrés sont repliables de manière indépendante, amovibles et combinés mécaniquement avec les mouvements de l'assise et du dossier, garantissant le maximum de confort pour le patient dans toutes les positions.

FOURNI DANS LA VERSION STANDARD



I due braccioli imbottiti sono amovibili e ripiegabili in maniera indipendente. Sono meccanicamente combinati con i movimenti del sedile e dello schienale, garantendo il massimo comfort per il Paziente in tutte le posizioni.

FORNITO NELLA VERSIONE STANDARD



EDGE P



Split Leg-rests ideal for Podiatry examination and treatments; extendable heel support and splay of 90°.

PROVIDED IN THE STANDARD VERSION

Jambières séparées pour la Pedicurie, avec talonnière extensible et une ouverture à 90° pour faciliter l'accès du patient.

FOURNI DANS LA VERSION STANDARD

Gambali separati per Podologia, con talloniera estensibile e con apertura a 90° per l'accesso facilitato del Paziente.

FORNITO NELLA VERSIONE STANDARD



Vertical movement and positioning of the leg-rests manually operated by the lever.

PROVIDED IN THE STANDARD VERSION

Soulevement et repositionnement des jambières actionnés par le levier.

FOURNI DANS LA VERSION STANDARD

Sollevamento e riposizionamento dei gambali azionati meccanicamente dalla leva.

FORNITO NELLA VERSIONE STANDARD



Telescopic leg-rests opening at 90° and performing a vertical movement of 90° adjustable by the handles on the sides.

PROVIDED IN THE STANDARD VERSION

Jambières télescopique écartant à 90° et effectuant un mouvement vertical de 90° réglable par le levier latérale.

FOURNI DANS LA VERSION STANDARD

Gambali telescopici con divaricazione fino a 90° e movimento verticale di 90° regolabile dalla leva laterale.

FORNITO NELLA VERSIONE STANDARD



EDGE P

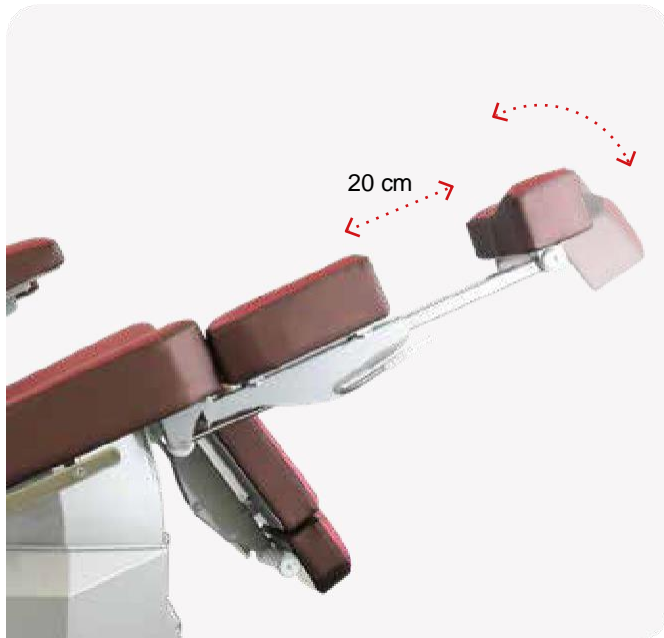

Double splitted leg-rests manually operated by lever and provided with stainless steel internal supports. Precise and Comfortable Positioning of the Patient's Foot with a clear view of the surgical area.

PROVIDED IN THE STANDARD VERSION

Jambières doubles réglées manuellement, équipés de supports en acier. Positionnement précis et confortable du pied du patient permettant le visuel parfait et complet de la zone du traitement.

FURNI DANS LA VERSION STANDARD

Gambale sdoppiato regolato manualmente, dotato di supporti in acciaio Inox.

Posizionamento preciso e confortevole del piede del Paziente in grado di fornire una visuale perfetta e completa dell'area di trattamento.

FORNITO NELLA VERSIONE STANDARD

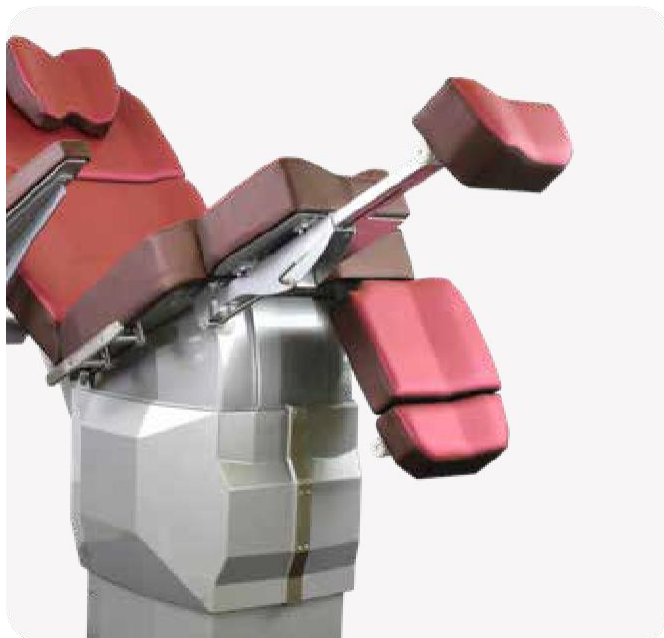

codice	descrizione
3510138	FLEXIBLE FOOT TRAY

Flexible foot tray, rollable and unbreakable. The silicon material always feels warm which makes it comfortable for the patient.

OPTIONAL

Tray flexible, enroulable et incassable. Le matériel en silicone reste toujours chaud, ce qui le rend confortable pour le patient.

EN OPTION

Vassoio flessibile ed infrangibile, comodo per il Paziente.

OPZIONALE





Kit for application system of plastic kidney trays for leg-rest.
OPTIONAL

Kit augettes en plastique pour les jambières.
EN OPTION

Kit vaschette in polipropilene da fissare ai gambali.
OPZIONALE

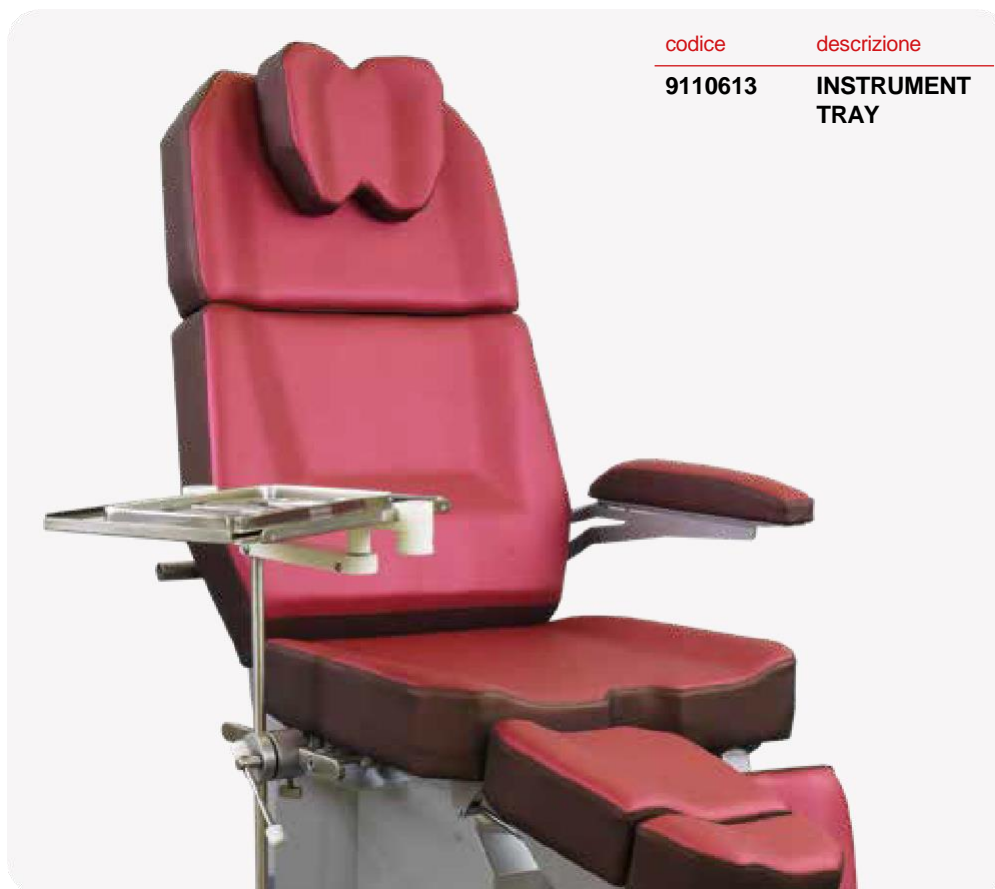

Instruments tray.
OPTIONAL

Plan pour instruments.
EN OPTION

Piano per strumenti.
OPZIONALE



codice	descrizione
9110643	SMART LIGHT

Technical features:

- Led technology
- Nominal voltage 230 v
- Frequency range 50hz
- Power consumpt 18w
- Dimensions diam. Ø 85 mm
- Lens 3,5 diottrie diam. 90 mm
- Net weight 3,5kg

OPTIONAL

Caractéristiques techniques:

- Technologie led
- Tension nominale 230 v
- Fréquence 50hz
- Consommation électrique 18w

- Dimensions diam. Ø 85 mm
- Loupe 3,5 dioptries diam. 90 mm
- Poids net 3,5 kg

EN OPTION

Caratteristiche tecniche:

- Tecnologia LED
- Tensione nominale 230 v
- Frequenza 50hz
- Assorbimento 18w
- Dimensioni diam. Ø 85 mm
- Lente 3,5 diottrie diam. 90 mm
- Peso netto 3,5 k

OPZIONALE

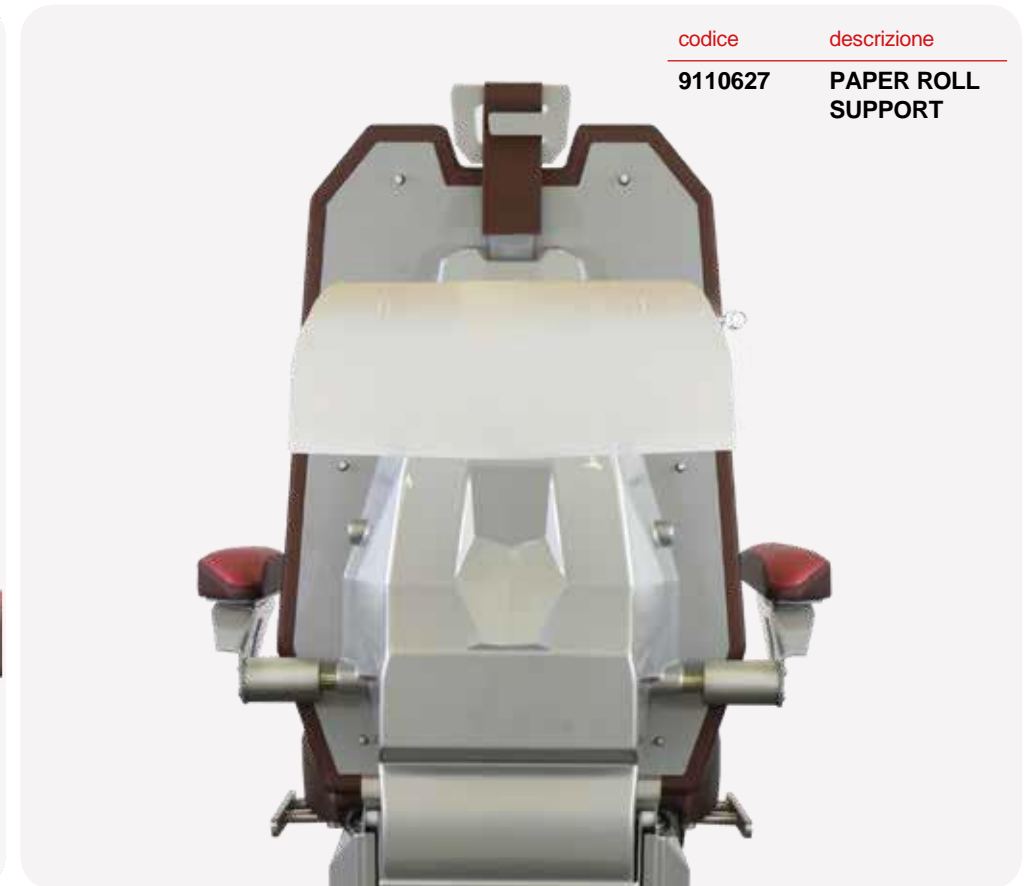

codice	descrizione
9110627	PAPER ROLL SUPPORT

Paper Roll Support, adjustable for different roll sizes.

OPTIONAL

Support rouleau papier, réglable en fonction de différentes tailles de rouleau requises.

EN OPTION

Supporto Rotolo Carta, regolabile per dimensioni diverse del rotolo richiesto.

OPZIONALE

EDGE P

codice	descrizione
9110609	LUMBAR SUPPORT PILLOW

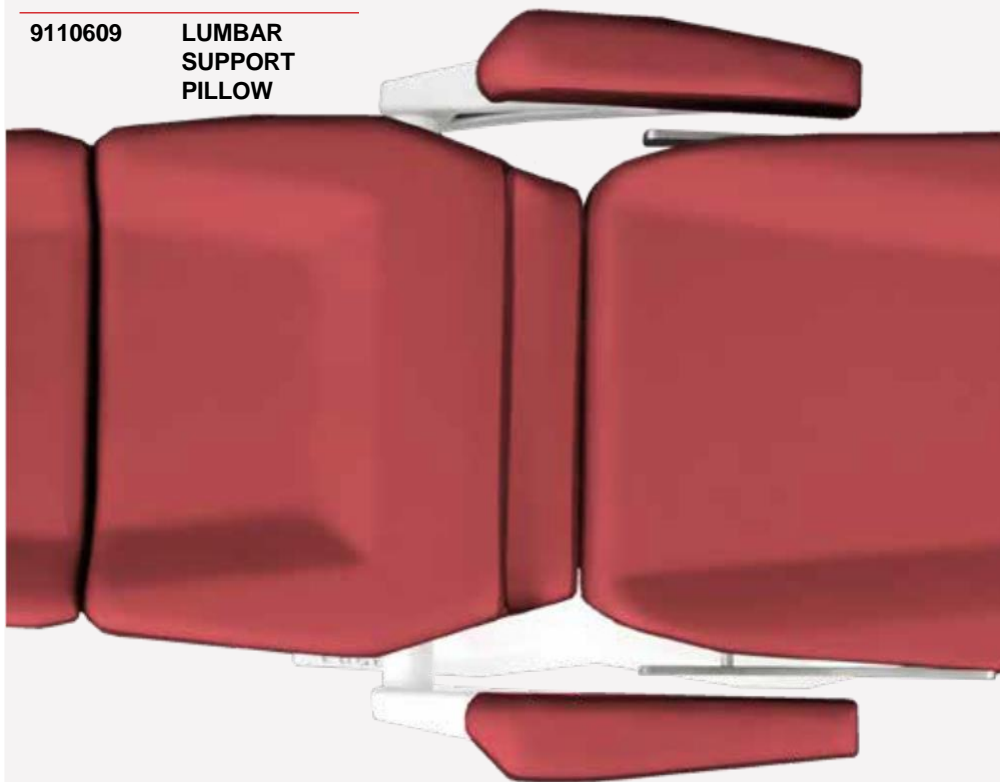

Lumbar Support Pillow guarantees maximum comfort to the patient in supine position.

OPTIONAL

Coussin pour le soutien lombaire, idéal pour le maximum du confort du patient en décubitus dorsal.

EN OPTION

Cuscino Supporto Lombare per il massimo comfort del Paziente in posizione supina.

OPZIONALE

ACCESSORIES - ACCESSOIRES - ACCESSORI

9110644	DRAPE SUPPORT
---------	------------------



Drape support with clamp included.

OPTIONAL

Support pour champs opératoires avec bloc de fixation inclus.

EN OPTION

Supporto telo con blocchetto di fissaggio.

OPZIONALE

EDGE P

ACCESSORIES - ACCESSOIRES - ACCESSORI

codice descrizione

9110634 **BACK UP
BATTERY**



Back up battery with 2Ah capacity allowing to operate the Chair in the event of a temporary power outage.

OPTIONAL

Batterie avec système back up et capacité de 2Ah permettant de gérer le Fauteuil en cas de coupure de courant temporaire.

EN OPTION

Batteria back up con capacità di 2Ah. Consente di movimentare la Poltrona in caso di interruzione momentanea della corrente elettrica.

OPZIONALE



codice descrizione

9110631 **RACK FOR
MEDICAL
ACCESSORIES
(white structure)**

9110631S **RACK FOR
MEDICAL
ACCESSORIES
(silver structure)**



Edge accessories rack inox.

OPTIONAL

Grille porte- accessoires Edge en inox.

EN OPTION

Carrello porta- accessori Edge in inox.

OPZIONALE



The seat naturally adapts to the user's body by increasing the contact area and decreasing the pressure on it. Circular seat with viscoelastic foam in different densities and memory effect. Multifunction armrest/ back rest in high resistant polyurethane. Base in steel and polished chrome. 5 self braking wheels. Adjustable height by gas piston. High quality skay cover.

OPTIONAL

Siège opérateur avec assise circulaire en mousse viscoélastique de différentes densités, avec effet mémoire. Accoudoir/ dossier multifonctionnel en polyuréthane de haute résistance. Appui-pied en acier chromé réglable en hauteur par vérin à gaz. Revêtement en skai de haute qualité.

EN OPTION

Sedia operatore con seduta circolare in schiuma viscoelastica a densità differenziata, con effetto memoria. Bracciolo/ schienale multifunzionale in poliuretano ad alta resistenza. Base in acciaio cromato. Altezza regolabile tramite molla a gas. Rivestimento con skai di alta qualità

OPZIONALE



Doctor stool with anatomical seat. Adjustable height of the backrest. Inclination angle of the backrest is adjustable in a fixed position or can dynamically support the back muscles. Control lever for all adjustments. Base in chromed steel. Seat height adjustable by gas spring. High quality skay coating.

OPTIONAL

Siège opérateur avec assise anatomique. Hauteur du dossier réglable. L'angle d'inclinaison du dossier est réglable dans une position fixe ou peut soutenir dynamiquement les muscles du dos. Réglages par levier. Base en acier chromé. Hauteur de l'assise réglable par vérin à gaz. Revêtement en skay de haute qualité.

EN OPTION

Sedia operatore con seduta anatomica. Altezza dello schienale regolabile. L'angolo di inclinazione dello schienale è regolabile in una posizione fissa o può supportare dinamicamente i muscoli della schiena. Leva di comando per tutte le regolazioni. Base in acciaio cromato. Altezza del sedile regolabile tramite molla a gas. Rivestimento in skay di alta qualità

OPZIONALE



Adjustable saddle-shaped seat. Polished and chromed steel base. 5 self-braking wheels. High quality skay coating
Hand-controlled adjustable height by gas piston: min 56 max 76 cm

OPTIONAL

Siège à selle de cheval réglable. Base en acier chromé. 5 roulettes auto-freinantes. Hauteur de l'assise réglable par piston à gaz: min 56, max 76. Revêtement skay de haute qualité

EN OPTION

Sedile con sella regolabile. Base in acciaio cromato. 5 ruote autofrenanti. Altezza del sedile regolabile tramite pistone a gas: min 56, max 76. Rivestimento in skay di alta qualità

OPZIONALE

EDGE SURGICAL SOLUTIONS develops and manufactures cabinets and furniture for: Ambulatory Surgery Center, Sterilisation Room, Outpatient Room and Front Office. The EDGE SURGICAL SOLUTIONS Furniture Project is paramount thanks to its innovative constructive and installation solutions that allow for an easier operating activity in the room, speed up the picking of needed instruments and material, guarantee the use of single modules as workstations during the procedures reducing obstacles and inefficiencies while allowing for a faster and easier disinfection of the operating area at the end of the activity when all modules can be stored back in the Corian® Garage. It's a space saving, clean and elegant setup that can be adapted to any room size.

Le site de production de EDGE SURGICAL SOLUTIONS développe et fabrique une gamme de mobilier sur-mesure pour: Ambulatoire de Chirurgie, Salle de stérilisation, Ambulatoire de Visite et Front Office. Le Projet Mobilier de EDGE SURGICAL SOLUTIONS se caractérise par une solution innovante de conception et d'installation à l'intérieur du Cabinet Médical, qui facilite l'ensemble des activités, comme les opérations de picking, permettant d'utiliser chaque modules comme desserte à outils en proximité de la zone d'activité et réduisant l'encombrement lors des interventions, tout en garantissant une désinfection parfaite et rapide. Une fois la journée de travail terminée, les meubles peuvent être facilement stockés à l'intérieur du garage réalisé entièrement en Corian®, facilitant les opérations de désinfection de la pièce, car l'encombrement étant réduit au minimum.

EDGE SURGICAL SOLUTIONS Progetta e Realizza nei suoi Stabilimenti Arredi su Misura per: Ambulatorio Chirurgico, Sala di Sterilizzazione, Ambulatorio Visita e Front Office. Il Progetto Arredi di EDGE SURGICAL SOLUTIONS è caratterizzato da un'innovativa soluzione costruttiva e di installazione che agevola l'attività dell'operatore in sala, facilita le operazioni di picking, permette di utilizzare i moduli come servomobili vicini alla zona operativa riducendo gli ingombri e le inefficienze durante gli interventi e garantisce una perfetta e veloce disinfezione e alla fine della giornata di lavoro possono essere facilmente riposti all'interno del garage interamente realizzato in Corian® agevolando le operazioni di disinfezione della sala riducendo al minimo gli ingombri.



EDGE SURGICAL SOLUTIONS cabinets are entirely built in metal sheet, riveted and painted with epoxy powder, the drawers modules are independent and mobile thanks to the 4 medical grade castors with 2 front brakes and no-mark rubber; the drawers are finished with metal front panels, different dimensions and colours at choice, push-pull opening/closing system and handles/free for a better and easier disinfection. The Sink is built in the Corian® working top and it guarantees perfect disinfection. State of the art design, elegant and high quality material, perfect ergonomics and absolute infection control define this EDGE SURGICAL SOLUTIONS unique project as a benchmark in Medical Furniture.

Les meubles EDGE SURGICAL SOLUTIONS sont entièrement fabriqués en acier riveté et peints à poudres époxy. Les éléments à tiroirs sont tous indépendants et mobiles, grâce à 4 roues anti-marques de qualité médicale équipées de deux freins à l'avant, d'une série de tiroirs de différentes tailles au choix et avec un système d'ouverture/fermeture Push-Pull. Les façades sont en acier peintes en différentes couleurs et sans poignées afin de garantir une parfaite désinfection. L'évier en Corian® s'intègre parfaitement au plan de travail, également réalisé en Corian®.

Un design de pointe, des matériaux élégants et de haute qualité, une ergonomie parfaite et une parfaite désinfection rendent le Projet Mobilier de EDGE SURGICAL SOLUTIONS une référence absolue en matière de mobilier médical.

Gli arredi EDGE SURGICAL SOLUTIONS sono interamente costruiti in lamiera di acciaio rivettata e verniciata con polveri epossidiche, i moduli cassettiera sono tutti indipendenti e mobili grazie alle 4 ruote medical-grade e anti-mark, dotate di due freni anteriori, cassetti di varie dimensioni a scelta e con sistema push-pull, pannelli frontali in lamiera di acciaio verniciati in diversi colori e senza maniglia per una più facile disinfezione, il lavello in Corian® è perfettamente integrato nel piano lavoro anch'esso interamente realizzato in Corian®. Una soluzione elegante, funzionale ed ergonomica unica sul mercato.





Garage Structure in steel and completely covered in Corian® to house the mobile modules. Splash-proof Corian® worktop guarantees easy cleaning and disinfection and long durability.

Structure du garage en Corian® (avec structure en acier) pour loger les meubles. Plan de travail en Corian® anti-éclaboussures garantit un nettoyage et une désinfection faciles et une longue durabilité.

Struttura a garage in Corian® (con rinforzo in acciaio) per ospitare i servomobili. Piano in Corian® con anti-splash, garantisce una facile pulizia e disinfezione e una grande durata nel tempo.



Drawers with push-pull system with stabilizer bar. Internal abs instruments trays for perfect disinfection and perfect storage.

Tiroirs avec système push pull avec barre stabilisatrice. Bac en plastique interne pour un nettoyage facile et une bonne organisation du rangement.

Cassetti con sistema di guide push pull con barra stabilizzatrice. Interni cassetto in plastica per una facile pulizia e una buona organizzazione del contenuto.



Mobile Cabinet Modules, 4 medical-grade, non-marking wheels equipped with two front brakes for easy maneuverability.

Meubles sur roues. 4 roues de qualité médicale et anti-marques équipées de deux freins à l'avant, pour une maniabilité aisée.

Servomobile su ruote. 4 ruote medical-grade e anti-mark, dotate di due freni anteriori, per una facile manovrabilità.



Corian® Worktop for an easier maneuverability of the mobile modules.

Plan de travail en Corian® avec poignée intégrée pour déplacer le meuble en toute simplicité.

Piano in Corian® con maniglia integrata per movimentare il servomobile con facilità.



Sink integrated on the Corian® worktop, available in both stainless steel and Corian® in different sizes and models.

Évier intégrables au plan en Corian®, disponibles aussi bien en acier inoxydable qu'en Corian® dans différentes tailles et modèles.

Lavabi integrabili nel piano in Corian®, disponibili sia in acciaio inox che in Corian® in diverse misure e modelli.



Hanging cabinets with drawers and flaps in different sizes and wall furniture with custom-made shelves.

Casiers suspendus avec tiroirs avec chevalet de différentes tailles et meubles hauts avec étagères sur mesure.

Pensili con cassetti a ribalta di varie dimensioni e pensili con ripiani realizzati su misura.



Possibility to integrate an archive and reporting desk with Methacrylate divider from operating area.

Possibilité d'intégrer un plan d'archive et reporting. Possibilité d'équiper avec séparateurs et paravent.

Possibilità di integrare un piano per la refertazione, dotabile di separè dalla parte operativa.



Possibility of integrating a stainless steel insert on the Corian® worktop to place the hot trays taken out from the autoclave.

Possibilité d'intégrer un insert en acier au-dessus du plan de travail en Corian® où placer les plateaux chauds sortant de l'autoclave.

Possibilità di integrare nel piano in Corian® un inserto in acciaio inox per appoggiare i vassoi caldi in uscita dall'autoclave.

Example of design tailored to the Customer
 Exemple de projet sur mesure pour le Client
 Esempio di progettazione su misura per il Cliente

FURNITURE - MEUBLES - ARREDI

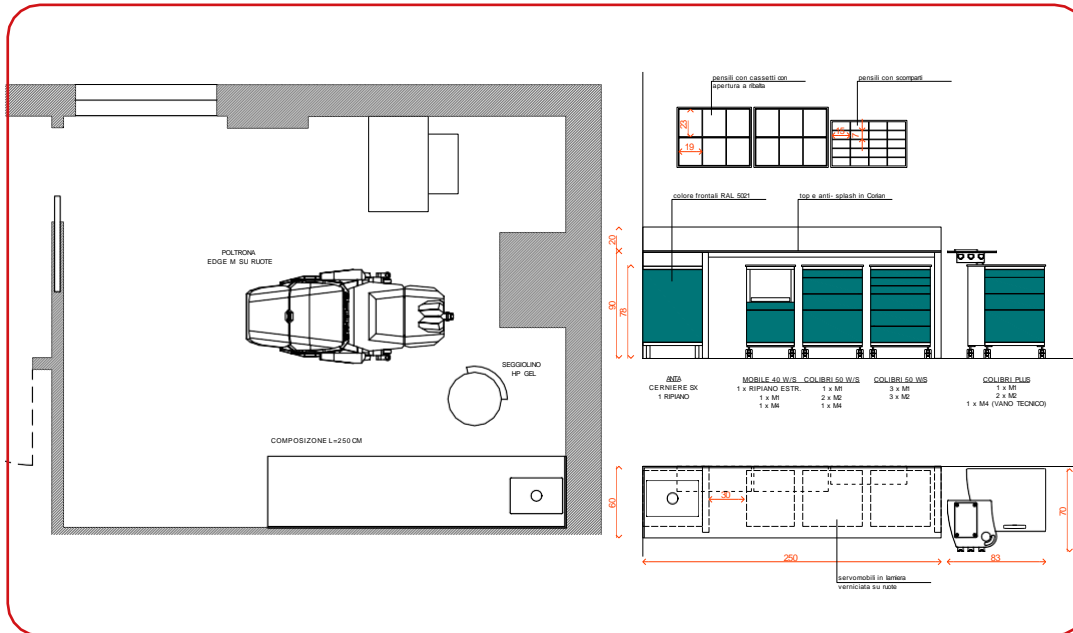

Corian® - Technical Sheet

- Corian® is a non-porous and homogeneous material, composed of approximately 1/3 acrylic resin and approximately 2/3 natural mineral substances.
- The junction points are imperceptible.
- Corian® surfaces are renewable (it can be fully restored to its original appearance by means of common detergents and an abrasive sponge).
- Corian® surfaces are hygienic.
- Corian® is an inert and non-toxic material.
- Corian® meets or exceeds emission guidelines for Volatile Organic Compounds (COV), Hazardous Air Pollutants (HAP).
- Chemical resistance. Class 1 reagents do not alter the material.

Corian® - Fiche Technique

- *Le Corian® est un matériau non poreux et homogène, composé d'environ 1/3 de résine acrylique et d'environ 2/3 de substances minérales naturelles.*
- *Les points de jonction sont imperceptibles.*
- *Les surfaces Corian® sont renouvelables (elles peuvent retrouver leur aspect d'origine à l'aide de produits communs détergents et d'une éponge abrasive).*
- *Les surfaces Corian® sont hygiéniques.*
- *Corian® est un matériau inerte et non toxique.*
- *Corian® respecte ou dépasse les directives d'émission pour les composés organiques volatils (COV), les polluants dangereux pour l'air (HAP).*
- *Résistance chimique. Les réactifs de classe 1 n'altèrent pas le matériau.*

STANDARD CONFIGURATION
CONFIGURATION STANDARD
CONFIGURAZIONE STANDARD

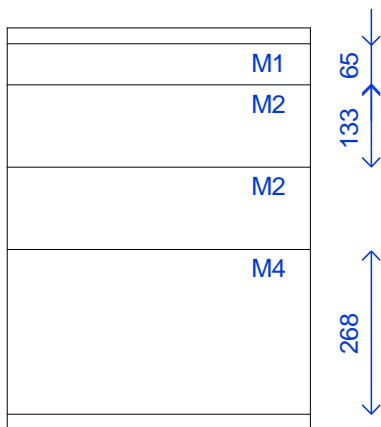

EXAMPLES OF POSSIBLE CONFIGURATIONS
EXEMPLES DE CONFIGURATIONS POSSIBLES
ESEMPI DI POSSIBILI CONFIGURAZIONI

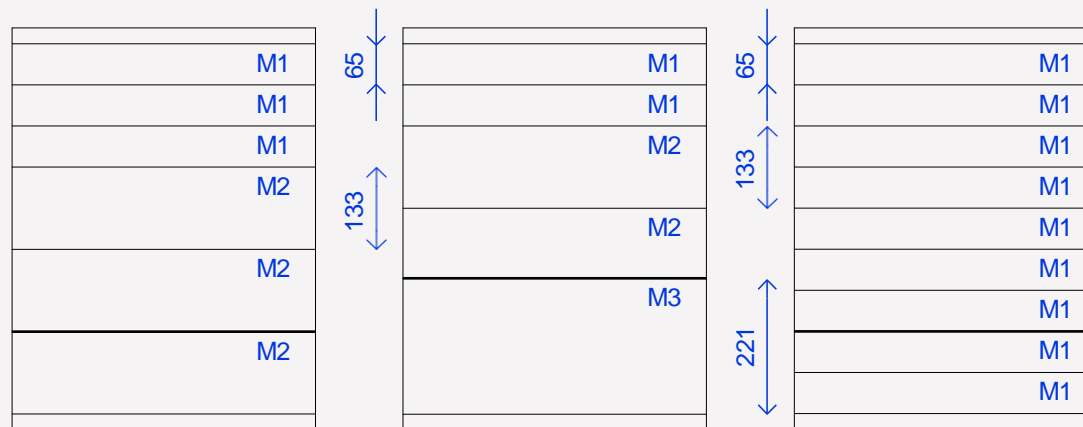

Corian® - Scheda Tecnica

- Corian® è un materiale non poroso e omogeneo, composto da circa 1/3 di resina acrilica e circa 2/3 di sostanze minerali naturali.
- Le giunture sono impercettibili.
- Le superfici in Corian® sono rinnovabili (si possono riportare all'aspetto originale con l'aiuto di normali detersivi e di una spugna abrasiva).
- Le superfici in Corian® sono igieniche.
- Corian® è un materiale inerte e non tossico.
- Corian® soddisfa o supera le linee guida delle emissioni per i composti organici volatili (COV), inquinanti pericolosi per l'aria (HAP).
- Resistenza chimica. I reattivi della classe 1 non alterano il materiale.

codice	descrizione
9210856	COLIBRÌ WORKSTATION



50 cm wide Cabinet with 4 drawers and metal fronts without handles provided with a Push-Pull opening system. Inside the drawers, storage trays for instruments. Cabinet on castors (front wheels equipped with brake) Worktop in Corian®.

OPTIONAL

Meuble de rangement de 50 cm de largeur avec 4 tiroirs et façades métalliques sans poignées équipés d'un système d'ouverture Push-Pull. A l'intérieur des tiroirs, plateaux de rangement. Meuble sur roulettes (les deux à l'avant équipés de frein) Plan de travail en Corian®.

EN OPTION

Mobile con larghezza 50 cm a 4 cassetti con frontali in metallo senza maniglie e sistema di apertura Push- Pull. All'interno dei cassetti, vassoi porta strumenti. Mobile su ruote (le due anteriori con freno) per la movimentazione e piano in Corian®.

OPZIONALE



codice	descrizione
9210868	COLIBRÌ M WORKSTATION



Cabinet 50 cm width. Standard configuration with 4 drawers with metal fronts without handles and Push-Pull opening system. Equipped with internal instrument trays. Corian® side compartment for the equipment lodging (load capacity 8 kg). Mobile on wheels for a comfortable handling (the two front wheels are equipped with brakes). Corian® worktop.

OPTIONAL

Meuble de rangement avec largeur 50 cm. Configuration standard avec 4 tiroirs à façades métalliques sans poignées et système d'ouverture Push-Pull. Équipé de plateaux d'instruments internes. Compartiment latéral en Corian® pour accueillir l'instrumentation (capacité de charge 8 kg). Meuble sur roues (les deux roues avant sont équipées de freins). Plan de travail en Corian®.

EN OPTION

Mobile con larghezza 50 cm. Configurazione standard con 4 cassetti con frontali in metallo senza maniglie e sistema di apertura Push- Pull. All'interno dei cassetti, vassoi porta strumenti. Vano laterale sotto piano per strumentazione (capacità di carico 8 kg). Mobile su ruote (le due anteriori con freno) per la movimentazione. Piano in Corian®.

OPZIONALE



Cabinet 85 cm width with 8 drawers (2 M1, 4 M2 e 2 M4) with metal fronts without handles and Push-Pull opening system. Equipped with internal instrument trays. Mobile on wheels for a comfortable handling (the two front wheels are equipped with brakes). Corian® worktop.

OPTIONAL

Meuble de rangement avec largeur 85 cm avec 8 tiroirs (2 M1, 4 M2 e 2 M4) à façades métalliques sans poignées et système d'ouverture Push-Pull. Équipé de plateaux d'instruments internes. Meuble sur roues (les deux roues avant sont équipées de freins). Plan de travail en Corian®.

EN OPTION

Mobile con larghezza 85 cm. Configurazione standard con 8 cassetti (2 M1, 4 M2 e 2 M4) con frontali in metallo senza maniglie e sistema di apertura Push- Pull. All'interno dei cassetti, vassoi porta strumenti. Mobile su ruote (le due anteriori con freno) per la movimentazione. Piano in Corian®.

OPZIONALE



Cabinet 90 cm width with 6 drawers (2 drawers 40 cm wide and 4 drawers 50 cm wide) with metal fronts without handles and Push-Pull opening system. Extendable metal shelf with Soft Touch system. Equipped with internal instrument trays. Mobile on wheels for a comfortable handling (the two front wheels are equipped with brakes). Corian® worktop.

OPTIONAL

Meuble de rangement avec largeur 90 cm avec 6 tiroirs (2 tiroirs largeur 40 cm et 4 tiroirs largeur 50 cm) à façades métalliques sans poignées et système d'ouverture Push-Pull. Étagère métallique extensible avec système Soft Touch. Équipé de plateaux d'instruments internes. Meuble sur roues (les deux roues avant sont équipées de freins). Plan de travail en Corian®.

EN OPTION

Mobile con larghezza 90 cm a 6 cassetti (2 cassetti largh. 40 cm e 4 cassetti largh. 50 cm) con frontali in metallo senza maniglie e sistema di apertura Push- Pull. Piano estraibile in lamiera con guida Soft Touch. All'interno dei cassetti, vassoi porta strumenti. Mobile su ruote (le due anteriori con freno) per la movimentazione. Piano in Corian®.

OPZIONALE

FRONT DRAWERS - TIROIRS AVANT - FRONTALI CASSETTI

RAL 9023 (1.06)	RAL 1035 (1.07)	RAL 9023 (1.08)	RAL 8029 (1.09)	RAL 9007 (1.10)	RAL 5026 (1.11)	RAL 7042 (2.05)	RAL 7015 (2.06)	RAL 4002 (2.07)	RAL 5013 (2.08)
RAL 1001 (2.09)	RAL 8028 (2.10)	PANTONE 389C (4.01)	RAL 5005 (4.02)	RAL 4010 (4.03)	RAL 6034 (4.05)	RAL 3017 (4.06)	RAL 7036 (4.07)	PANTONE 391C (5.04)	RAL 8023 (5.05)
RAL 3031 (5.06)	RAL 1002 (5.07)	RAL 5023 (5.08)	RAL 7024 (5.09)	RAL 7021 (6.07)	RAL 5008 (6.08)	RAL 5009 (6.09)	RAL 7037 (6.10)	RAL 7036 (6.11)	RAL 8019 (6.12)
RAL 5000 (6.13)	RAL 5007 (6.14)	RAL 6027 (6.15)	RAL 5025 (6.16)	RAL 6000 (6.17)	RAL 3005 (6.18)	RAL 3027 (6.19)	RAL 3022 (6.20)	RAL 1032 (6.21)	RAL 1019 (6.22)
RAL 8017 (7.07)	RAL 7006 (7.08)	RAL 7044 (7.09)	RAL 3005 (7.10)	RAL 6003 (7.11)	RAL 5009 (7.12)	RAL 5022 (8.30)	RAL 3003 (8.31)	RAL 7040 (8.32)	RAL 9010 (8.33)
RAL 7036 (8.34)	RAL 8025 (8.35)	RAL 8017 (8.36)	RAL 5009 (8.37)	RAL 6034 (8.38)	PANTONE 391C (8.39)	RAL 1023 (8.40)	RAL 4010 (8.41)	RAL 8019 (9.03)	RAL 2003 (9.04)
RAL 3020 (9.05)	RAL 3005 (9.06)	RAL 8004 (9.07)	RAL 9006 (9.08)	RAL 5007 (9.09)	RAL 5013 (9.10)	RAL 7035 (9.11)	RAL 5023 (9.12)	RAL 5024 (9.13)	RAL 6027 (9.14)
RAL 7021 (9.15)	RAL 7039 (9.16)	RAL 7037 (9.17)	RAL 1013 (9.18)	RAL 1015 (9.19)	RAL 8024 (9.20)	RAL 8016 (9.21)	RAL 1036 (9.22)	RAL 4005 (9.23)	RAL 7021 (10.01)

UPHOLSTERY - SELLERIE - TAPPEZZERIA

EDGE SURGICAL SOLUTIONS Cool

1.06	1.07	1.08	1.09	1.10	1.11
------	------	------	------	------	------

EDGE SURGICAL SOLUTIONS Urban

4.01	4.02	4.03	4.05	4.06	4.07
------	------	------	------	------	------

EDGE SURGICAL SOLUTIONS Brio

6.07	6.08	6.09	6.10	6.11	6.12
6.13	6.14	6.15	6.16	6.17	6.18
6.19	6.20	6.21	6.22		

EDGE SURGICAL SOLUTIONS Voyager

9.03	9.04	9.05	9.06	9.07	9.08
9.09	9.10	9.11	9.12	9.13	9.14
9.15	9.16	9.17	9.18	9.19	9.20
9.21	9.22	9.23			

EDGE SURGICAL SOLUTIONS Glamour

2.05	2.06	2.07	2.08	2.09	2.10
------	------	------	------	------	------

EDGE SURGICAL SOLUTIONS Trend

5.04	5.05	5.06	5.07	5.08	5.09
------	------	------	------	------	------

EDGE SURGICAL SOLUTIONS Premium

7.07	7.08	7.09	7.10	7.11	7.12
------	------	------	------	------	------

EDGE SURGICAL SOLUTIONS Classic

8.30	8.31	8.32	8.33	8.34	8.35
8.36	8.37	8.38	8.39	8.40	8.41

EDGE SURGICAL SOLUTIONS Antistatic

10.01

UPHOLSTERY - SELLERIE - TAPPEZZERIA

EDGE SURGICAL SOLUTIONS Cool

- Fireproof
EN 1021.1-2
IMO MSC 88/26/ADD.2 PART 8
(3.1&3.2), ISO 3795
- Bleach resistant
- REACH Compliant
Non toxic
Non heavy metals
No mercury
- No Bisphenol A (BPA)
- RoHS Compliant
- No PBTs (Persistent Bio accumulative and Toxic Chemicals)
- No significant colour change or stiffening
UV coef ≥ 7
- Bromine-free, no Halogenated Flame Retardants (HFRs)
- Abrasion resistant
100.000 cycles
- Phthalates free
- Mildew resistant

EDGE SURGICAL SOLUTIONS Trend

- Fireproof
EN 1021.1-2
IMO MSC 88/26/ADD.2 PART 8
(3.1&3.2)
- Bleach resistant
- REACH Compliant
Non toxic
Non heavy metals
No mercury
- No Bisphenol A (BPA)
- RoHS Compliant
- No PBTs (Persistent Bio accumulative and Toxic Chemicals)
- No significant colour change or stiffening
UV coef ≥ 7
- Bromine-free, no Halogenated Flame Retardants (HFRs)
- Abrasion resistant
100.000 cycles
- Fire resistant additives free
Antimicrobial resistant additive free
Phthalates free

EDGE SURGICAL SOLUTIONS Classic

- Fireproof
M1 (NFP 92503)
BS 5852 crib 5
B2 (DIN 4102)
EN 1021.1-2
IMO A652
FAR 25853 App F Part1 v12
CATB 117 E
CATB 133
UFAC CLASS 1
NY/NJ-Port Authority
AM 18 (NFD 60-013)
- Waterproof
- Efficacy against bacteria (MRSA)
- Abrasion resistant
ISO 5470-2
150.000 cycles (12 KPa)
- Colour fastness to artificial light ≥ 6
- Phthalates free

EDGE SURGICAL SOLUTIONS Glamour

- Fireproof
EN 1021.1-2
IMO MSC 88/26/ADD.2 PART 8
(3.1&3.2), ISO 3795
- Bleach resistant
- REACH Compliant
Non toxic
Non heavy metals
No mercury
- No Bisphenol A (BPA)
- RoHS Compliant
- No PBTs (Persistent Bio accumulative and Toxic Chemicals)
- No significant colour change or stiffening
UV coef ≥ 7
- Bromine-free, no Halogenated Flame Retardants (HFRs)
- Abrasion resistant
100.000 cycles
- Phthalates free
- Mildew resistant

EDGE SURGICAL SOLUTIONS Brio

- Fireproof
BS EN 1021-1 and 2
NF P 92-503 (M2)
IMO MSC 88/26/ADD.2 PART 8
(3.1&3.2)
CATB 117-2013
UFAC CLASS 1
- Bleach resistant
- REACH Compliant
Non toxic
Non heavy metals
No mercury
- No Bisphenol A (BPA)
- RoHS Compliant
- No PBTs (Persistent Bio accumulative and Toxic Chemicals)
- No significant colour change or stiffening
UV coef ≥ 7
- Bromine-free, no Halogenated Flame Retardants (HFRs)
- Abrasion resistant
300.000 cycles
- Phthalates free
- Anti-microbial
Mildew resistant

EDGE SURGICAL SOLUTIONS Voyager

- Fireproof
CL 1/ IM-M2-CRIB 5
- Waterproof
- UV resistant, low temp. resistant
- Mildew resistant, antibacterial and antimicrobial
- Free of heavy metal, formaldehyde, mercury and solvents
- Abrasion resistant
ISO 5470-2
100.000 cycles
- Chemical resistant to acid, bases, alcohol and common solvent

EDGE SURGICAL SOLUTIONS Urban

- Fireproof
M2 (NFP 92503)
BS 5852 crib 5
B2 (DIN 4102)
EN 1021.1-2
IMO A652
FAR 25853 App F Part1 v12
CATB 117 E
CATB 133
UFAC CLASS 1
NY/NJ-Port Authority
AM 18 (NFD 60-013)
- Waterproof
- Efficacy against bacteria (MRSA)
- Abrasion resistant
ISO 5470-2
120.000 cycles (12 KPa)
- Colour fastness to artificial light ≥ 6
- Phthalates free

EDGE SURGICAL SOLUTIONS Premium

- Fireproof
M2 (NFP 92503)
BS 5852 crib 5
B2 (DIN 4102)
EN 1021.1-2
IMO A652
FAR 25853 App F Part1 v12
CATB 117 E
CATB 133
UFAC CLASS 1
NY/NJ-Port Authority
AM 18 (NFD 60-013)
- Waterproof
- Efficacy against bacteria (MRSA)
- Abrasion resistant
ISO 5470-2
80.000 cycles (12 KPa)
- Colour fastness to artificial light ≥ 6
- Phthalates free

EDGE SURGICAL SOLUTIONS Antistatic

- Electrically conductive (antistatic) synthetic leather
- Fireproof
GOST
- REACH Compliant
- Electric Resitivity
 $10^4-10^6 \Omega$
- Phthalates free
- No significant colour change or stiffening ≥ 6

DIMENSIONS AND TECHNICAL SHEETS
DIMENSIONS ET FICHES TECHNIQUES
DIMENSIONI E DATI TECNICI

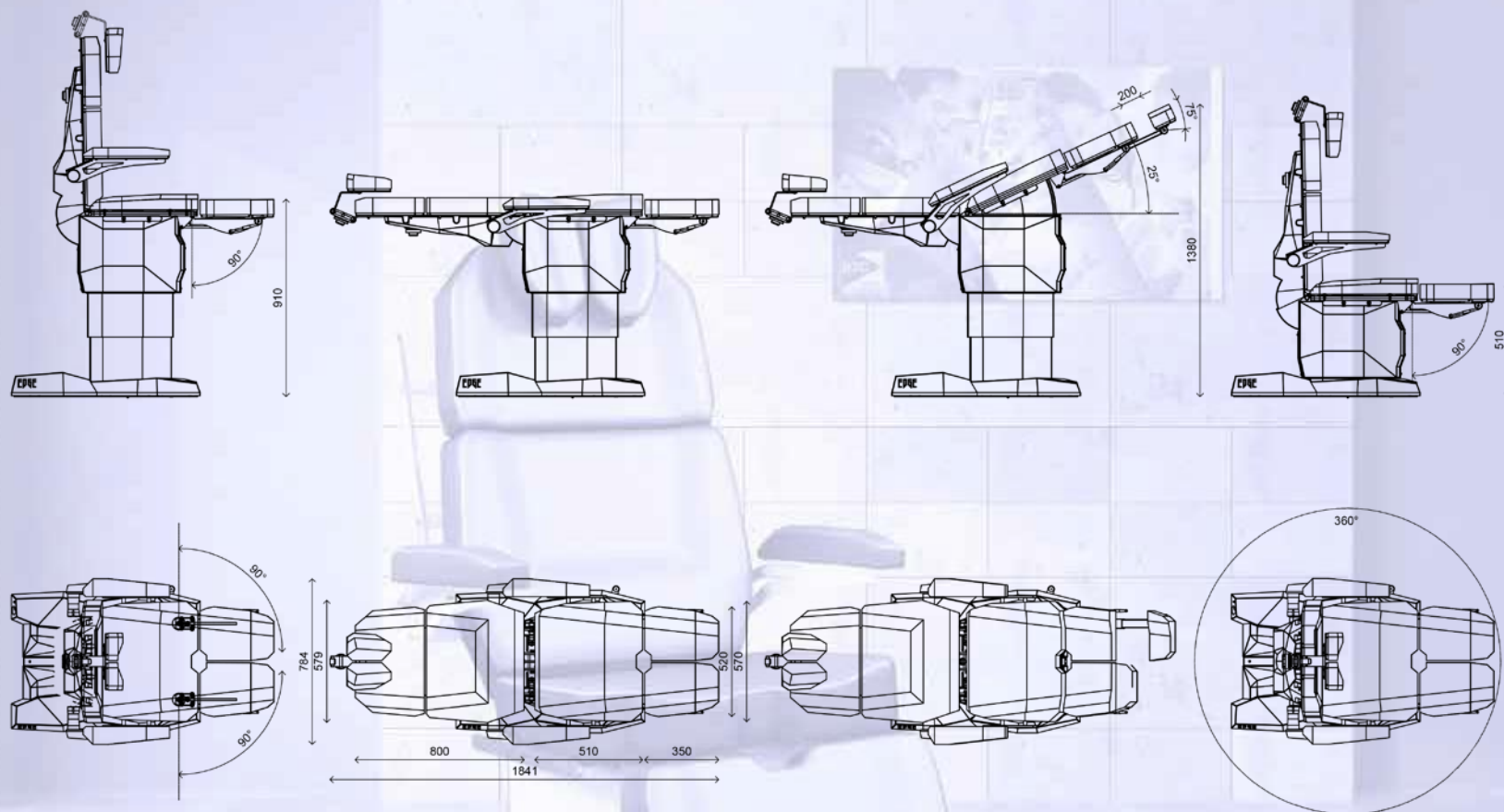

Supply <i>Alimentation</i> Alimentazione	110- 230 V 50- 60 Hz
Operating voltage <i>Voltage</i> Tensione di rete	24 V
Absorption <i>Absorption</i> Assorbimento	350 W
Maximum load <i>Capacité maximum</i> Capacità di carico	325 Kg

Maximum load on foot-rest <i>Capacité maximum sur jambière</i> Capacità di carico sul gambale	85 Kg
Maximum load on arm-rest <i>Capacité maximum sur accoudoir</i> Capacità di carico sul bracciolo	75 Kg
Maximum load on back-rest <i>Capacité maximum sur dossier</i> Capacità di carico sullo schienale	75 Kg
Weight of the chair <i>Poids du fauteuil</i> Peso della poltrona	140 Kg



Podiatry Examination/
Surgery Chair



Registered Community Design



www.edgesurgicalsolutions.com



edgesurgicalsolutions@gmail.com



*“All EDGE SURGICAL SOLUTIONS Medical Equipment is designed ,
developed and manufactured in Italy”*

EDGE SURGICAL SOLUTIONS Srl

Headquarter: Via Umberto I, 48 73039 Tricase (LE) –ITALY

Production Site: S.S.275 ALESSANO-LUCUGNANO KM 17,5
ALESSANO (LE) - ITALY